

Architon

 **Işıklar**
YAPI ÜRÜNLERİ

CERAM
BERSALACQUA
GÜNEŞKIRICILAR
ÖZELKAROLAR
COTTOARCHITON

Architon

Architon Tek Cidarlı / <i>Architon Single Skin</i>	2
Ceram / <i>Ceram</i>	6
Bersal / <i>Bersal</i>	10
Acqua / <i>Acqua</i>	15
Güneş Kırıcılar / <i>Louvers</i>	18
Özel Karolar / <i>Special Tiles</i>	22
Cotto / <i>Cotto</i>	35

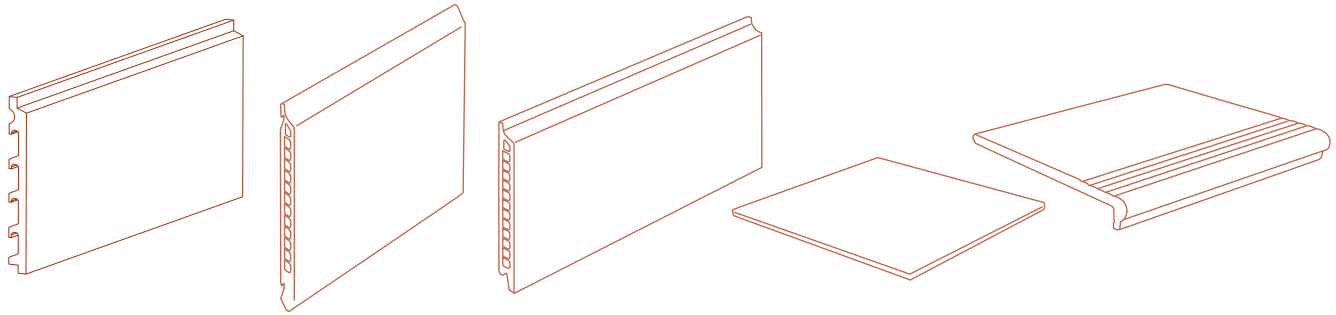



Farklı renkleriyle tasarımcıların hayallerinin gerçekleşmesini sağlayan Architon, yüksek üretim kapasitesi sayesinde, istenilen ölçülerde ve renklerde kısa sürede şantiyeye sevk edilebiliyor.

Architon enables the realization of the dreams of designers with different colors , thanks to its high production capacity , can be shipped to the site as soon as the desired sizes and colors.

Architon

Tek Cidarlı

Single Skin



■ Teknik Özellikler / Technical Specifications

Dikey Sistem / Vertical System

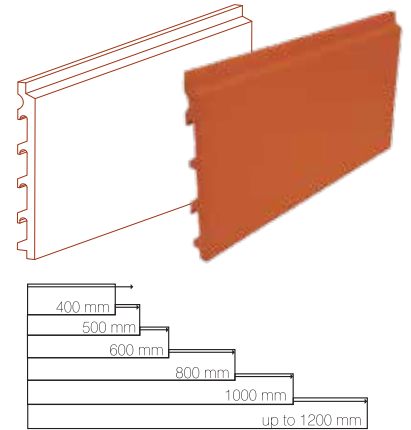
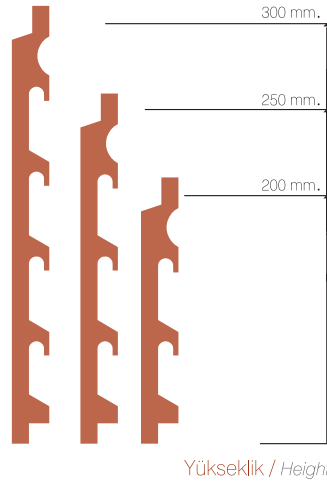

Uzunluk / Length
Kalınlık / Thickness 22 mm.
Ağırlık / Weight 30 kg/m²

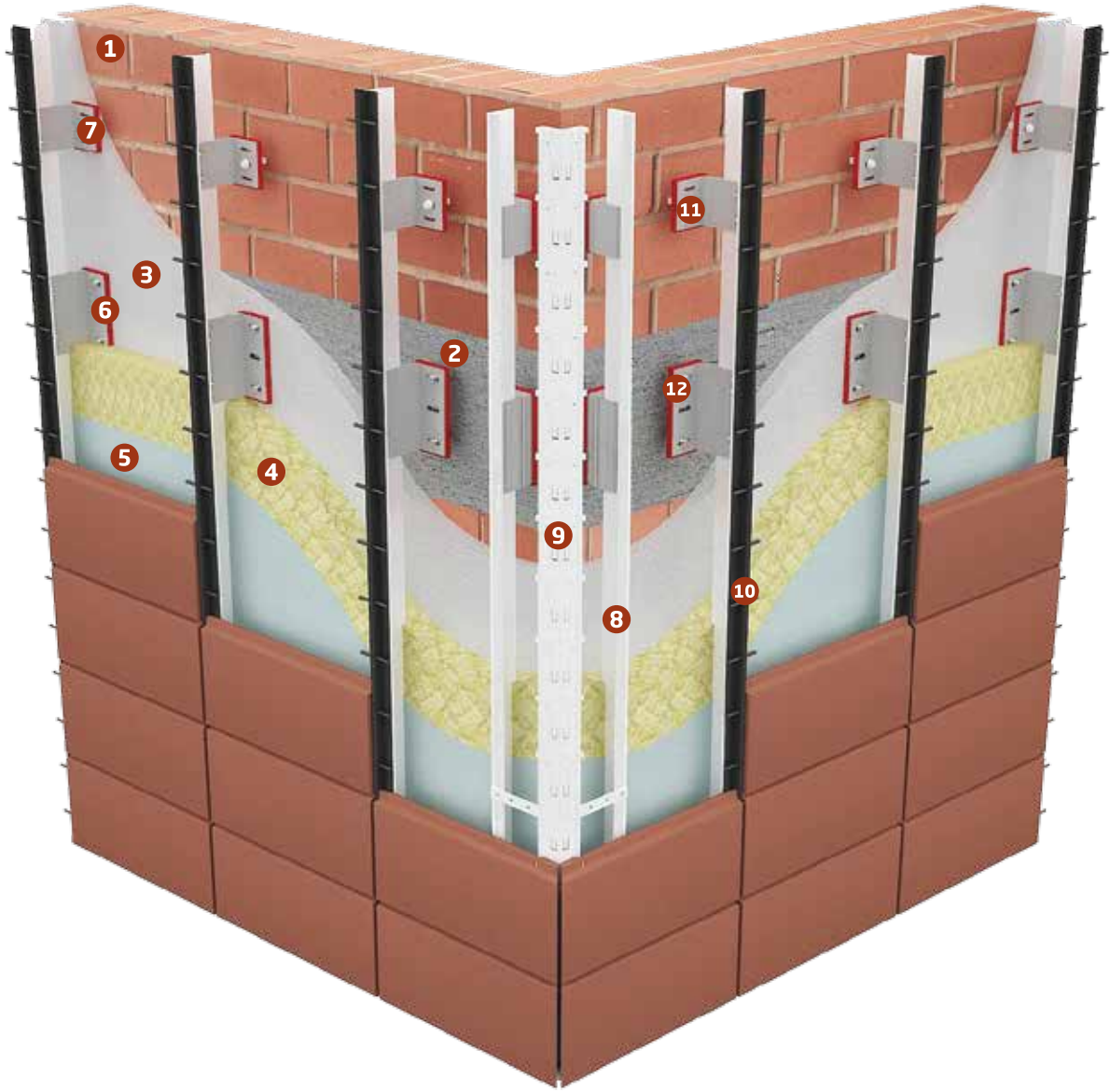

Dikey Sistem / Vertical System

- | | |
|--|---|
| 1 Tuğla Duvar / Brick Wall | 7 Hareketli İzofix Braket / Moving İzofix Bracket |
| 2 Betonarme Döşeme / Concrete Coating | 8 Düşey Taşıyıcı T Profili / Vertical Carrier T Profile |
| 3 Sıva / Plaster | 9 Fuga Askı Profili / Fuga Hanging Profile |
| 4 Taş Yünü / Rock Wool | 10 Köşe Dönüş ve Bitim Profii / Side Corner and End Profile |
| 5 Buhar Dengeleyici Örtü / Steam Balancing Cover | 11 Çelik Dübel - Tuğla Dübeli / Steel Screw - Brick Screw |
| 6 Sabit İzofix Braket / Fixed İzofix Bracket | 12 Bağlantı Vidaları ve Perçinleri / Connecting Screws and Rivets |

STANDART RENKLER

Standard Colors

Referans/Reference

Renk/Color





28 mm kalınlığındaki Terra Cotta karo, çeşitli yüksekliklerde ve en fazla 1500 mm uzunluğunda sunulmaktadır. Bindirmeli yatay birleştirme sayesinde hava boşluğuna su girmesi önlenerek binanın teknik performansı geliştirilir.

The 28 mm thick ceramic tile is presented in several heights and a maximum length of 1500 mm. The overlapping horizontal joints prevent water entering into the air gap, improving the technical performance of the building.

CERAM

Çift Cidarlı Kalın
Architon

Double Skin-Thick



■ Teknik Özellikler / Technical Specifications

Dikey Sistem / Vertical System

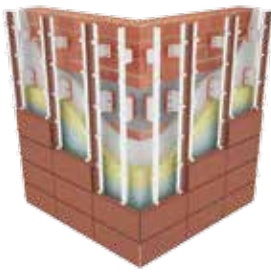

Yatay Sistem / Horizontal System

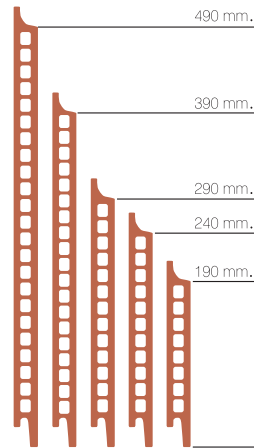

Yükseklik / Height

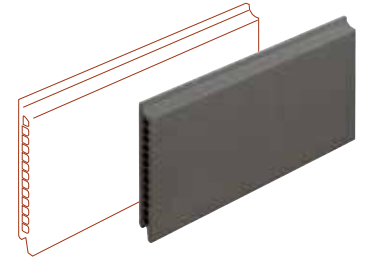

Uzunluk / Length
Kalınlık / Thickness 28 mm.
Ağırlık / Weight 48 kg/m²

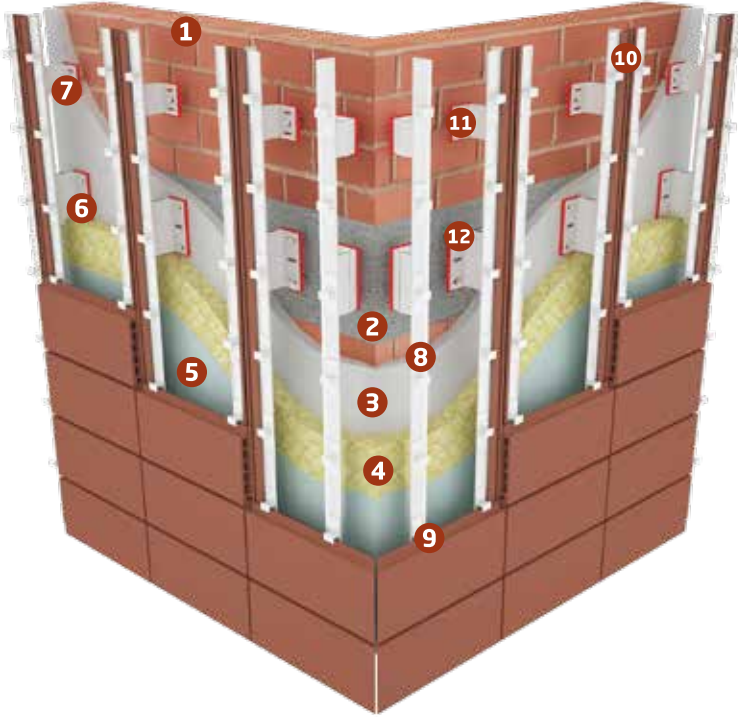

Dikey Sistem / Vertical System

- 1 Tuğla Duvar / Brick Wall
- 2 Betonarme Döşeme / Concrete Coating
- 3 Sıva / Plaster
- 4 Taş Yünü / Rock Wool
- 5 Buhar Dengeleyici Örtü / Steam Balancing Cover
- 6 Sabit İzofix Braket / Fixed İzofix Bracket
- 7 Hareketli İzofix Braket / Moving İzofix Bracket
- 8 Düşey Taşıyıcı T Profili / Vertical Carrier T Profile
- 9 Ara - Alt - Üst Klips / Inside - Bottom - Top Clips
- 10 Fuga Derz Profili / Fuga Hanging Profile
- 11 Çelik Dübел - Tuğla Dübeli / Steel Screw - Brick Screw
- 12 Bağlantı Vidaları ve Perçinleri / Connecting Screws and Rivets

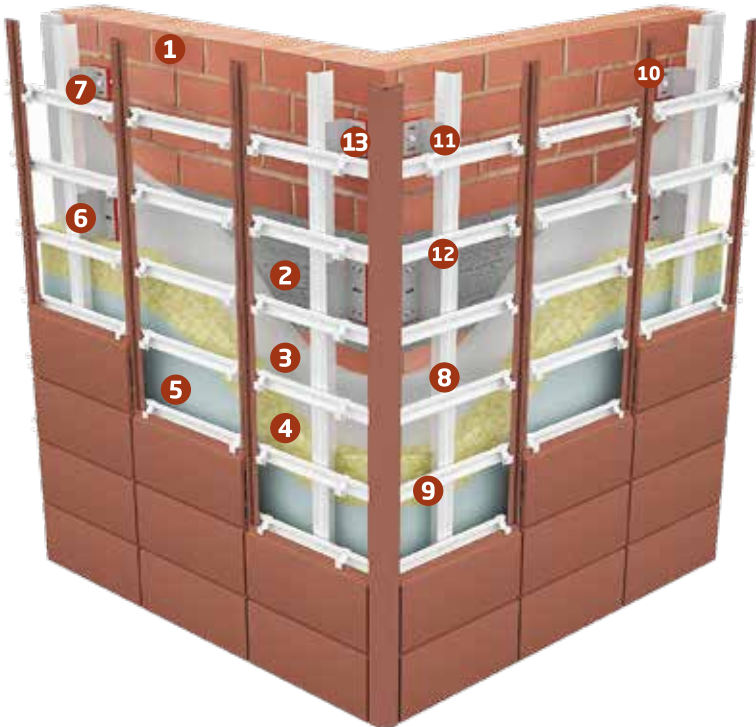

Yatay Sistem / Horizontal System

- 1 Tuğla Duvar / Brick Wall
- 2 Hareketli İzofix Braket / Moving İzofix Bracket
- 3 Sabit İzofix Braket / Fixed İzofix Bracket
- 4 Sıva / Plaster
- 5 Buhar Dengeleyici Örtü / Steam Balancing Cover
- 6 Betonarme Döşeme / Concrete Coating
- 7 Taş Yünü / Rock Wool
- 8 Düşey Taşıyıcı T Profili / Vertical Carrier T Profile
- 9 Ara - Alt - Üst Klips / Inside - Bottom - Top Clips
- 10 Fuga Askı Profili / Fuga Hanging Profile
- 11 Çelik Plastik Dübел / Steel Plastic Screw
- 12 Yatay Taşıyıcı Profil / Horizontal Carrier Profile
- 13 Bağlantı Vidaları ve Perçinleri / Connecting Screws and Rivets

Architon

CERAM

Çift Cidarlı Kalın
Architon
Double Skin-Thick

A Ref. BS07	
A Ref. NA01	
B Ref. NA03	
B Ref. TE02	
A Ref. RO011	
C Ref. NE04	
A Ref. GR03	
C Ref. AZ03	
A Ref. TU02	

Doğal/Nature GR00A	
Doğal/Nature MA04A	
Doğal/Nature BS00A	
Doğal/Nature R004A	
Doğal/Nature RO021A	
Doğal/Nature M5005A	
Doğal/Nature M50A	

Doğal/Nature GR00	
Doğal/Nature MA04	
Doğal/Nature BS00	
Doğal/Nature R004	
Doğal/Nature RO021	
Doğal/Nature M5005	
Doğal/Nature M50	

Metal Renkler/ Metalic Colors



Bakır/Copper



Gümüş/Silver

Çift Cidarlı İnce BERSAL Architon

Double Skin-Thin



■ Teknik Özellikler / Technical Specifications

Dikey Sistem / Vertical System



Yatay Sistem / Horizontal System

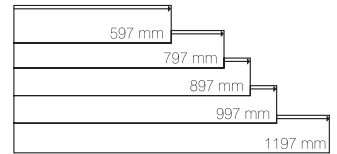
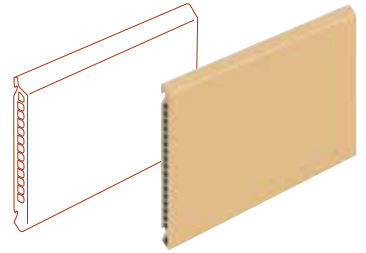
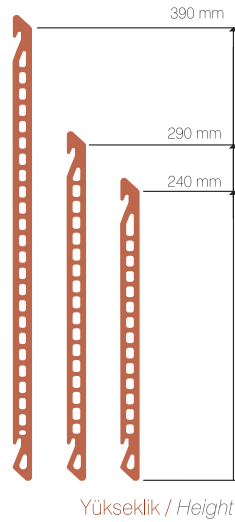
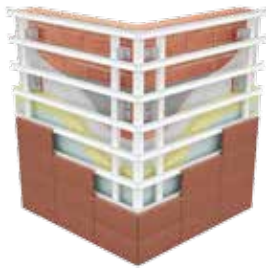

Uzunluk / Length
Kalınlık / Thickness 16 mm.
Ağırlık / Weight 32 kg/m²

Architon BERSAL 16mm kalınlığında olup, m²'ye getirmiş olduđu 32 kg ağırlık ile farklı çözümler sunmaktadır. Çok amaçlı kullanıma uygun ve yenileme projeleri için ideal bir üründür.

Architon BERSAL is 16mm thick, offers a variety of solutions has been brought to 32 kg m². It is ideal for multi-purpose use and suitable for renovation projects.

Dikey Sistem / Vertical System

- 1 Tuğla Duvar / Brick Wall
- 2 Betonarme Döşeme / Concrete Coating
- 3 Sıva / Plaster
- 4 Taş Yünü / Rock Wool
- 5 Buhar Dengeleyici Örtü / Steam Balancing Cover
- 6 Sabit İzofix Braket / Fixed İzofix Bracket
- 7 Hareketli İzofix Braket / Moving İzofix Bracket
- 8 Düşey Taşıyıcı T Profili / Vertical Carrier T Profile
- 9 Çelik Fuga Askı Profili / Steel Fuga Hanging Profile
- 10 Köşe Dönüş ve Bitim Profili / Corner and End Profile
- 11 Çelik Dübel - Tuğla Dübeli / Steel Screw - Brick Screw
- 12 Bağlantı Vidaları ve Perçinleri / Connecting Screws and Rivets

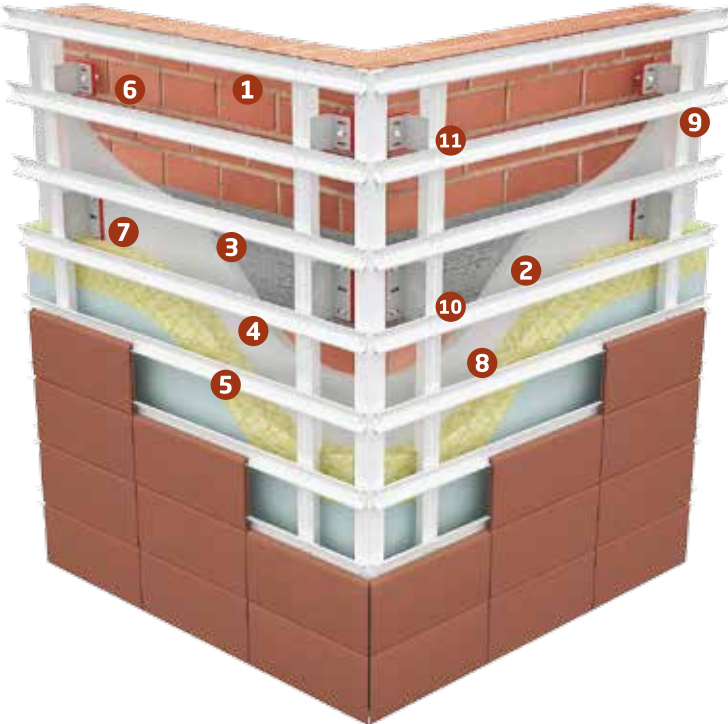

Yatay Sistem / Horizontal System

- 1 Tuğla Duvar / Brick Wall
- 2 Hareketli İzofix Braket / Moving İzofix Bracket
- 3 Sabit İzofix Braket / Fixed İzofix Bracket
- 4 Sıva / Plaster
- 5 Buhar Dengeleyici Örtü / Steam Balancing Cover
- 6 Betonarme Döşeme / Concrete Coating
- 7 Taş Yünü / Rock Wool
- 8 Düşey Taşıyıcı T Profili / Vertical Carrier T Profile
- 9 Yatay Taşıyıcı Profil / Horizontal Carrier Profile
- 10 Çelik Plastik Dübel / Steel Plastic Screw
- 11 Bağlantı Vidaları ve Perçinleri / Connecting Screws and Rivets

Architon

Çift Cıdarlı İnce
BERSAL Architon
Double Skin-Thin

A Ref. BS07	
A Ref. NA01	
B Ref. NA03	
B Ref. TE02	
A Ref. RO011	
C Ref. NE04	
A Ref. GR03	
C Ref. AZ03	
A Ref. TU02	

Doğal/Nature GR00A	
Doğal/Nature MA04A	
Doğal/Nature BS00A	
Doğal/Nature R004A	
Doğal/Nature RO021A	
Doğal/Nature M5005A	
Doğal/Nature M50A	

Doğal/Nature GR00	
Doğal/Nature MA04	
Doğal/Nature BS00	
Doğal/Nature R004	
Doğal/Nature RO021	
Doğal/Nature M5005	
Doğal/Nature M50	

Metal Renkler/ *Metalic Colors*

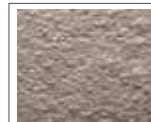

Bakır/Copper



Gümüş/Silver

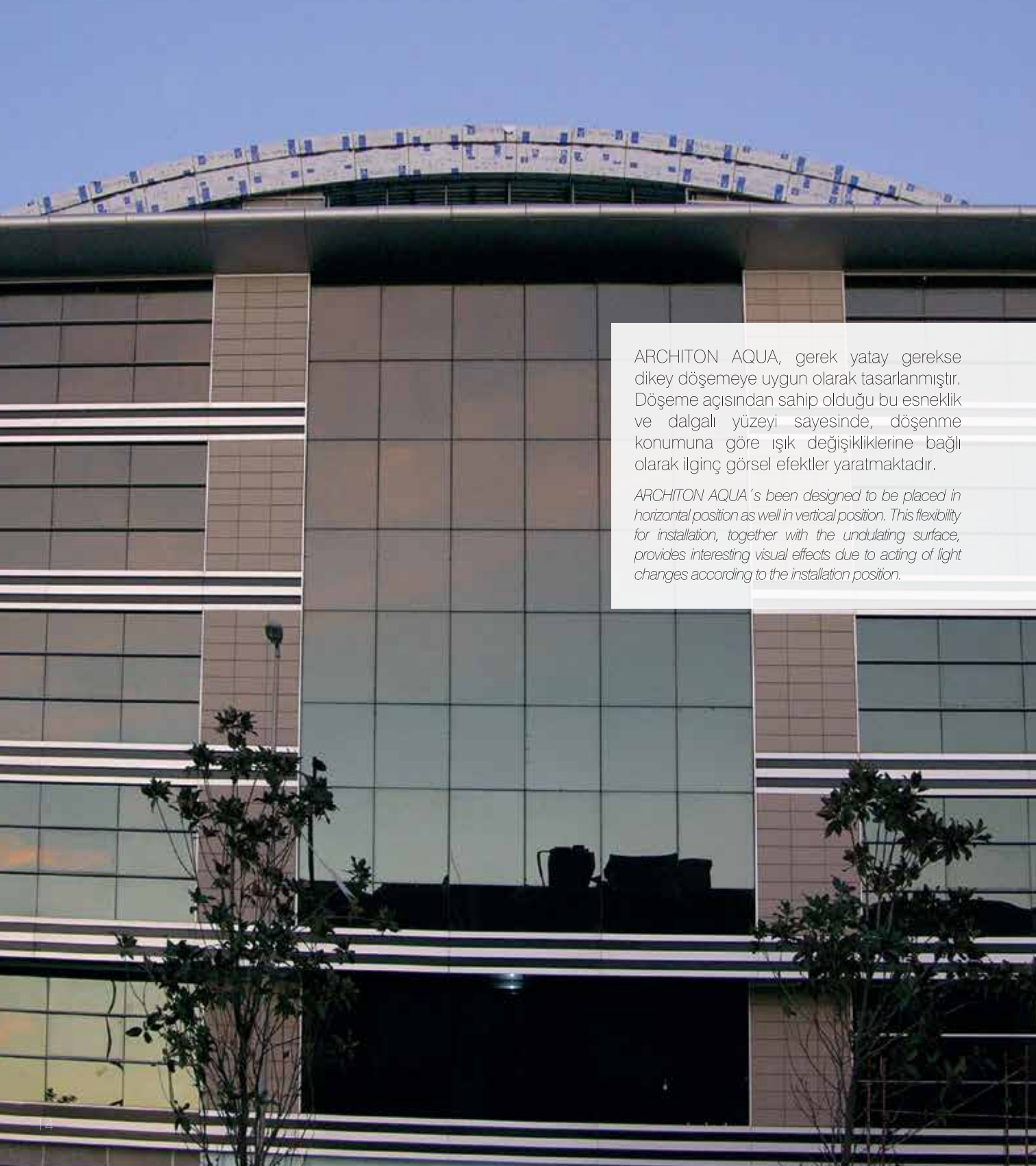

ARCHITON AQUA, gerek yatay gerekse dikey döşemeye uygun olarak tasarlanmıştır. Döşeme açısından sahip olduğu bu esneklik ve dalgalı yüzeyi sayesinde, döşenme konumuna göre ışık değişikliklerine bağlı olarak ilginç görsel efektler yaratmaktadır.

ARCHITON AQUA 's been designed to be placed in horizontal position as well in vertical position. This flexibility for installation, together with the undulating surface, provides interesting visual effects due to acting of light changes according to the installation position.

ACQUA **Architon**



■ Teknik Özellikler / Technical Specifications

Dikey Sistem / Vertical System

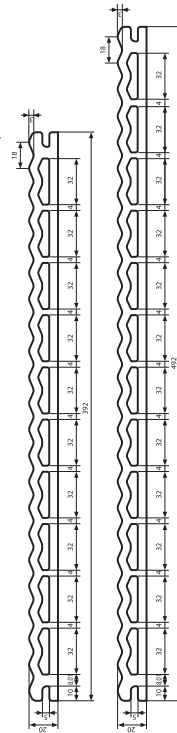
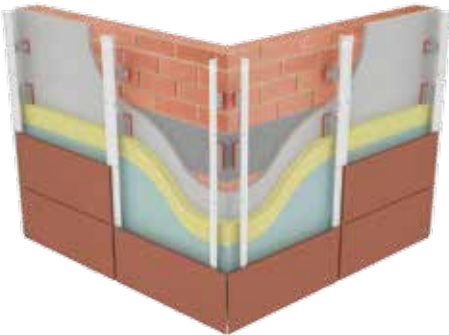

Kalınlık / Thickness 20 mm.
Ağırlık / Weight 48 kg/m²

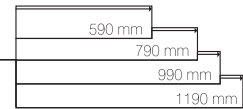

UZUNLUK / LENGTH

Uzunluk / Length



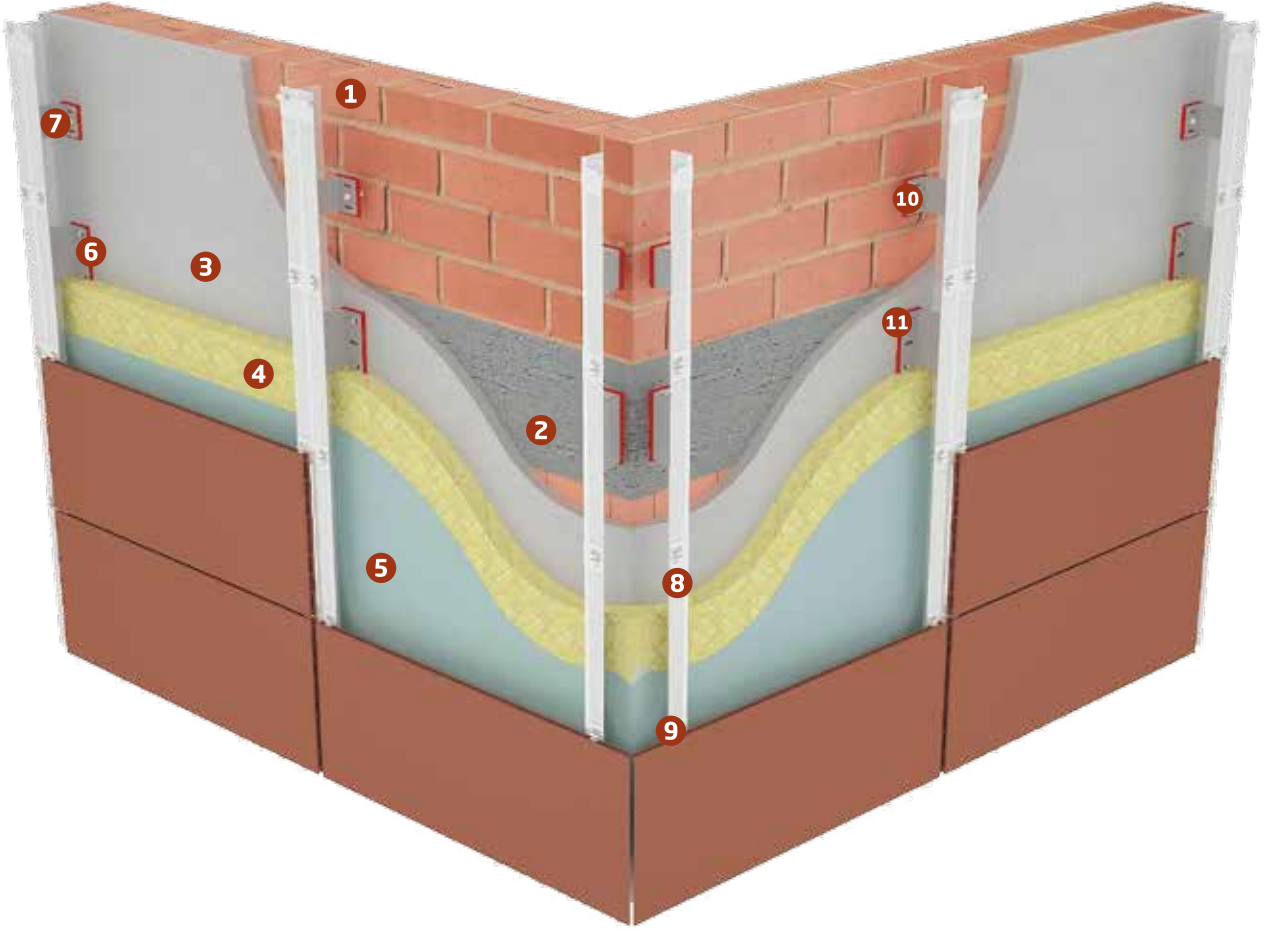

Dikey Sistem / Horizontal System

- | | | | |
|---|--|----|--|
| 1 | Tuğla Duvar / Brick Wall | 6 | Sabit İzofix Braket / Fixed İzofix Bracket |
| 2 | Betonarme Döşeme / Concrete Coating | 7 | Hareketli İzofix Braket / Moving İzofix Bracket |
| 3 | Siva / Plaster | 8 | Düsey Taşıyıcı Profili / Vertical Carrier T Profile |
| 4 | Taş Yünü / Rock Wool | 9 | Paslanmaz Alt - Ara Üst Clip / Stainless Bottom - Inside - Top Clips |
| 5 | Buhar Dengeleyici Örtü / Steam Balancing Cover | 10 | Çelik Dübel - Tuğla Dübelli / Steel Screw - Brick Screw |
| | | 11 | Bağlantı Vidaları ve Perçinleri / Connecting Screws and Rivets |

Acqua Uygulama Sistemleri / Acqua Application Systems

Architon

Tüm ARCHITON ACQUA Terra Cotta karoları 20 mm kalınlığındadır. Yeşil ve mavinin yanı sıra ARCHITON renk paletinin tüm tonlarında sunulmaktadır.

All the ARCHITON ACQUA tiles are 20 mm thick. Available in shade of green, blue and the entire ARCHITON color range.

Havalandırmalı Cephe Sistemleri /

Ventilated Facade Systems

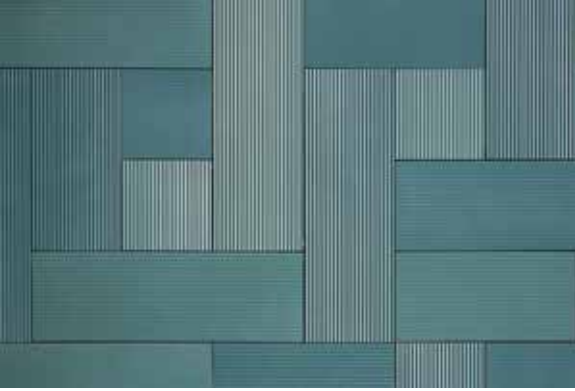

ARCHITON AQUA, gerek yatay gerekse dikey dösemeye uygun olarak tasarlanmıştır. Döşeme açısından sahip olduğu bu esneklik ve dalgalı yüzeyi sayesinde, döşeme konumuna göre ışık değişikliklerine bağlı olarak ilginç görsel efektler yaratmaktadır.

ARCHITON AQUA 's been designed to be placed in horizontal position as well in vertical position. This flexibility for installation, together with the undulating surface, provides interesting visual effects due to acting of light changes according to the installation position.



Terracotta panellerin dalgalı yüzeyi, farklı pozisyonlarda döşendiğinde cepheye hacim ve doku katar. Işık demetlerinin etkisiyle algılanan ton değişimleri cepheye özgün ve kişilikli bir görünüm verir.

The waves of the ceramic tiles, placed in different orientations, provide volume and texture in the facade. With the impact of rays of light, the facade shows shades which give it originality and character.



Güneş kırıcılar, yapılara istenildiği oranda güneş ışınlarının girmesini sağlar. Çağdaş tasarımlara fonksiyonel çözümler getirir. Pencereelerde, balkonlarda, klima ünitelerinin korunmasında, havalandırma boşluklarında, dış cephe merdivenlerinde, iç mekan bölmelerinde kullanılır.

The louvre blades allows sunlight to enter the desired ratio structures. Brings functional solutions for contemporary design. In windows, balconies, in the protection of air conditioning unit in the ventilation shafts, the stairs in the facade, used in interior compartment.

Güneş Kırıcılar

Architon

Louvers



ARCHITON; briol, java, orona, espheric olmak üzere dört farklı şekilde çeşitli Terracotta güneş kırıcılar sunuyor.

ARCHITON offers a wide variety of ceramic louvers with four different shapes: briol, java, orona, espheric

Ağırlık/Weight

Briol

X
50 mm
60 mm

Y
50 mm
60 mm

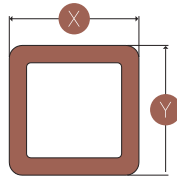

5,5 KG/ML

Java

X
60 mm
50 mm
60 mm

Y
120 mm
130 mm
150 mm

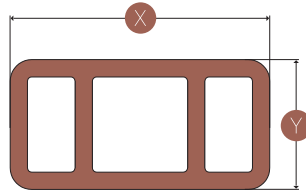

10 KG/ML

GÜNEŞ KIRICILAR

Louvers

ARCHITON; briol, java, orona, espheric olmak üzere dört farklı şekilde çeşitli Terracotta güneş kırıcılar sunuyor.

ARCHITON offers a wide variety of ceramic louvers with four different shapes: briol, java, orona, espheric

Ağırlık/Weight

Spheric

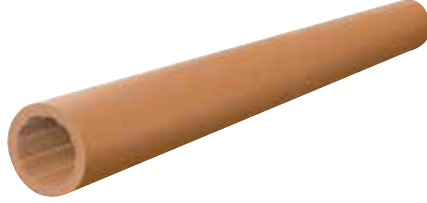
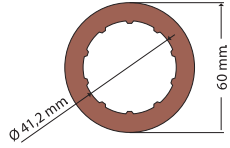

Orona

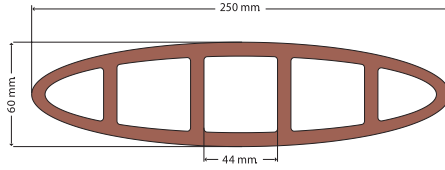

14KG/ML

ÖN GERMELİ GÜNEŞ KIRICILAR

Prestressed Louvers

Güneş kırıcıların ön germeli olarak birleştirilmesiyle oluşturulan yekpare gövde, üç metreye kadar uzunluklarda kanatlara ulaşmamızı sağlamaktadır. Farklı kanat türlerine uygulanabilen bu prosedür, destek yapısını azaltır ve görünümü hafifletir.

Trough the prestressing of a louver assembly, a monolithic body is built that allows us to reach up to three meters long louvers that can be applied to different kind of louvers, reduces the supporting structure and lightens the appearance



GÜNEŞ KIRICI UYGULAMA SİSTEMLERİ

Louver Application Systems



Havalandırmalı Cephe Sistemleri / *Ventilated Facade Systems*



BRIOL

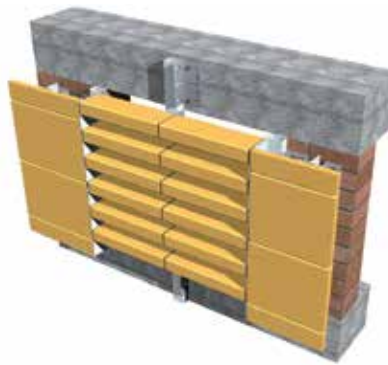

JAVA

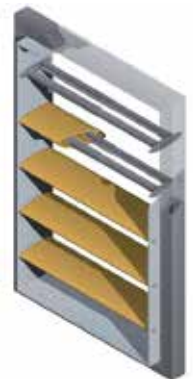

ORONA

ÖZEL KAROLAR

Special Tiles

Ekstrüzyon yöntemiyle Terra Cotta üretimi, başka üretim yöntemleriyle elde edilmesi mümkün olmayan özgün desenlerin yaratılmasını sağlamaktadır. ARCHITON, projelerin temel ihtiyaçlarını karşılayan ve karoların mimari tasarıma uyarlanmasına olanak veren geniş bir model ve özel parça yelpazesine sahiptir.

The ceramic extrusion achieves unique designs that are impossible to be made by other manufacturing process. Architon has a wide range of models and special pieces covering the basic needs of projects and adapting tiles to architectural design.

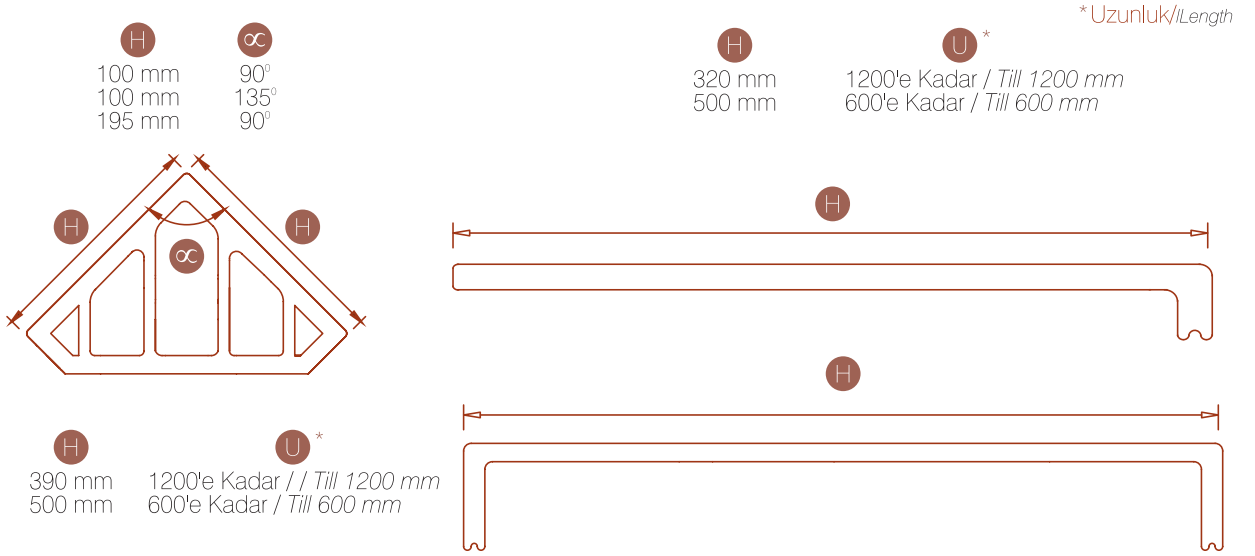

∞	U^*
390 mm	1200'e Kadar // Till 1200 mm
500 mm	600'e Kadar / Till 600 mm

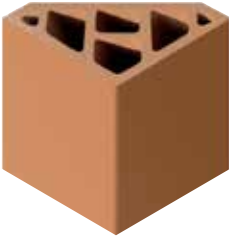

Köşe / Corner

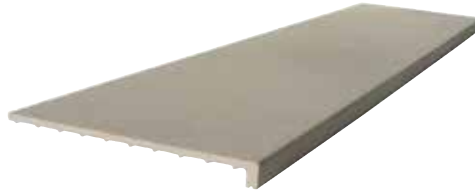

Pencere Pervazı / Window Sill



Geçme / Copping

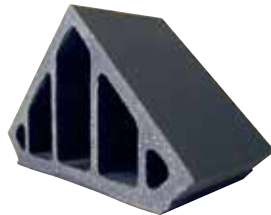









STANDART VE METALİK RENKLER

Standard and Metallic Colors

Referans/Reference

Renk/Color

A Ref. BS07	
A Ref. NA01	
B Ref. NA03	
B Ref. TE02	
A Ref. RO011	
C Ref. NE04	
A Ref. GR03	
C Ref. AZ03	
A Ref. TU02	

Metal Renkler/
Metallic Colors



Bakır/Copper



Gümüş/Silver

DOĞAL RENKLER

Natural Colors

Referans/Reference

Renk/Color

Doğal/Nature GR00A		Doğal/Nature GR00	
Doğal/Nature MA04A		Doğal/Nature MA04	
Doğal/Nature BS00A		Doğal/Nature BS00	
Doğal/Nature R004A		Doğal/Nature R004	
Doğal/Nature R0021A		Doğal/Nature R0021	
Doğal/Nature M5005A		Doğal/Nature M5005	
Doğal/Nature M50A		Doğal/Nature M50	



ÖZEL RENKLER

Special Colors



Normal/Normal



Kayrak/Slate



Emaye/Enameled

Özellikler Tablosu / Table of Properties

Özellikler/Properties	Standart/Rule	Architon Değerleri /Architon Values
Toleranslar-Tolerances	ISO 10545-2	- Uzunluk (Ekstrüzyon Yönü)/Length (Extrusion Direction) +/- 1 mm * - Yükseklik/Height +/- 2 mm * - Kalınlık/Thickness +/- 10% * - Düzlük (Ekstrüzyon Yönü) uzunluğunu/Straightness (Extrusion Direction) +/- 0,3% of length * - Dikdörtgenlikten sapma yüksekliği/Rectangularity +/- 1% of height - Yüzey düzlüğü köşegenin veya yüksekliğinin/Surface Flatness +/- 0,5% of diagonal or height
*Ölçülere veya formata göre/ According to dimensions or format.		
Su Emme/Water absorption	ISO 10545-3	Renge bağlı olarak <1% or 3-6% - Depending on color <1% or 3-6%
Eğilme Mukavemeti/Bending strength	ISO 10545-4	Renge bağlı olarak -Depending on color - FVC 15-20N/mm2 – FVB 14-18N/mm2
Lineer termal genişleme katsayısı/ Linear thermal coefficient of expansion	ISO 10545-8	Genişleme katsayısı-Coefficient of expansion $5,7 \times 10^{-6}$ (K ⁻¹) Test ITC.
Isı şokuna dayanım/ Resistance to thermal shock	ISO 10545-9	Teste göre 145°C'ye kadar değiştirilemez.Unalterable up to 145°C, according to test.
Rutubet genişleme katsayısı/ Coefficient of moisture expansion	ISO 10545-10	Ortalama değer-Mean value <0,1 mm/m,maksimum değer-maximum value <0,1 mm/m Test ITC.
Dona karşı dayanıklılık/Frost resistance	ISO 10545-12	Teste göre değiştirilemez-Unalterable according to test (100 cycles + 5°C a -5°C.)
Kimyasal dayanımı/Chemical resistance	ISO 10545-13	Sadece aşındırıcı koşullarda geçerli. En az G ve B sınıfı. Only applicable in corrosive conditions. At least G and B class.
Leke dayanımı/Stain resistance	ISO 10545-14	En az-At least CLASS 3.
Renk farklılığı/Color differences	ISO 10545-16	$\Delta E < 2$, doğal renk-nature colors <3







Architon





Architon

CAFÉ



Binalar için teknik ve estetik çözümler sunar. Kare ve dikdörtgen formlara sahip olan Cotto, üç farklı rengeyle profesyonellere fonksiyonel çözümler getirir.

Offers technical and aesthetic solutions for buildings. Having square and rectangular forms Cotton brings functional solutions for professionals with three different colors.

COTTO

Cephe

Facade

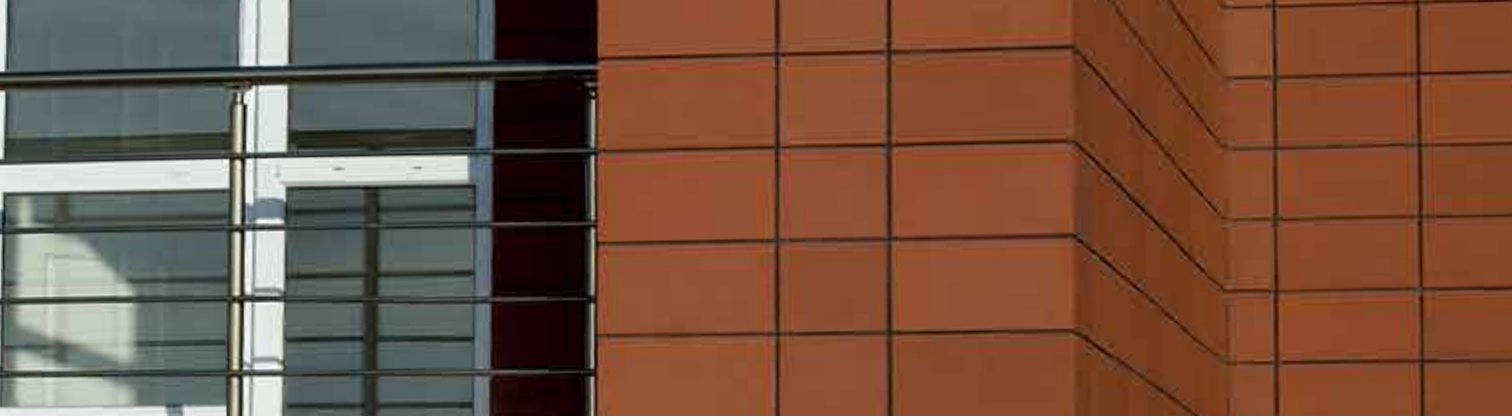

■ Teknik Özellikler / Technical Specifications

CT/1E Ekstrude(extruded)

Ebat/Dimension : 240x240x15 mm

Ağırlık/Weight : 1,770 kg

Adet / pcs. / m² : 16



CT/20E Ekstrude(extruded)

Ebat / Dimension : 200x400x15 mm

Ağırlık / Weight : 2,150 kg

Adet / pcs. / m² : 12,5



COTTO Cephe

Facade



■ Teknik Özellikler / *Technical Specifications*

CT/20E-S Ekstrude(*extruded*)

Ebat/Dimension : 200x400x15 mm

Ağırlık/Weight : 2,150 kg

Adet / pcs. / m² : 12,5









Archilab





Architon



**Ürünlerde baskıdan kaynaklı renk değişiklikleri oluşabilir.
There may be color changes in products sourced from printing.

Lights shine where there are buildings,
“**ışıklar**” will be shining where life is!

 **ışıklar**
YAPI ÜRÜNLERİ

ışıklar

Y A P I Ü R Ü N L E R İ

Gn. Md. ve Marmara Bölge Müdürlüğü

Orhan Veli Kanık Cd. Yakut Sk.
Eryılmaz Plz. 34810 Kavacık-Istanbul
+90 (216) 537 00 50 +90 (216) 537 00 59
marmara@isiklartugla.com.tr

Fabrika

Ağdacı Köyü Mevkii-Bartın
+90 (378) 227 12 33
+90 (378) 227 15 43
karadeniz@isiklartugla.com.tr

İhracat Müdürlüğü / Foreign Trade

Orhan Veli Kanık Cd. Yakut Sk.
Eryılmaz Plz. 34810 Kavacık-Istanbul
+90 (216) 537 00 50 +90 (216) 537 00 58
foreigntrade@isiklar.com.tr

İç Anadolu ve Akdeniz Bölge Müdürlüğü

Gençlik Cd. No: 9 Anıttepe-Ankara
+90 (312) 231 40 85
+90 (312) 230 07 03
icanadolu@isiklartugla.com.tr

Akdeniz Depo

Topçular Mh. 1019 Sk. No: 117
Yeni Samra Pazarı Muratpaşa-Antalya
+90 (242) 324 34 11 +90 (242) 324 35 08
akdeniz@isiklartugla.com.tr

Karadeniz Bölge Müdürlüğü

Güzel Yalı Mh. Atatürk Bulvarı Kemal Bektaş
Konutları A Blok No:170 Atakum-Samsun
+90 (362) 437 30 01 +90 (362) 437 30 02
kaydinoglu@isiklar.com.tr

Ege Bölge (İzmir)

+90 533 282 55 83 (Kuzey Ege)
sture@isiklar.com.tr
+90 533 271 65 81 (Güney Ege)
byildirim@isiklar.com.tr

Muğla İrtibat Ofisi

Şeyh Mh. Ragıp Bey Cd. No: 6 Menteşe-Muğla
+90 (252) 214 05 44
+90 (533) 272 65 82
vgazezoglu@isiklar.com.tr

Güney ve Doğu Anadolu Blg. Müdürlüğü

Cemalpaşa Mh. 63012 Sk. No: 6/A Adana
+90 (322) 457 45 29
+90 (322) 458 18 73
gdanadolu@isiklartugla.com.tr